



CE

Operating instructions
Through-beam sensor

UK

O5E5xx / O5S5xx

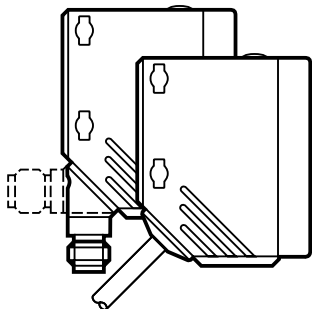

1 Preliminary note

1.1 Symbols used

- ▶ Instruction
- > Reaction, result
- [...] Designation of pushbuttons, buttons or indications
- Cross-reference



Important note

Non-compliance can result in malfunctions or interference.

2 Functions and features

The through-beam sensor detects objects and materials without contact and indicates their presence by a switching signal.

Range: → type label.

3 Installation

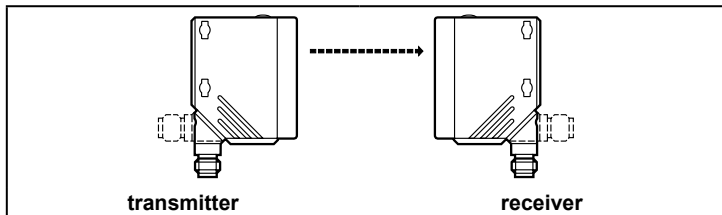

- ▶ Install the receiver (O5E...) and secure it to a bracket.
- ▶ Align the transmitter (O5S...) to the receiver and fix it.

Maximum range only with accurate alignment.

4 Operating and display elements

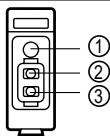

receiver

- 1: LED yellow
- 2: [OUT on] button
- 3: [OUT off] button

5 Electrical connection



The unit must be connected by a qualified electrician.

- ▶ The national and international regulations for the installation of electrical equipment must be adhered to.
- ▶ Ensure voltage supply to EN 50178.

▶ Disconnect power.

▶ Connect the unit as follows:

Transmitter connector

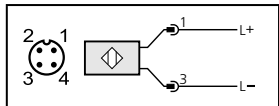

Transmitter cable *

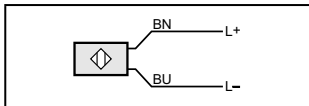

Receiver connector

PNP

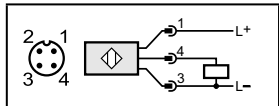

NPN

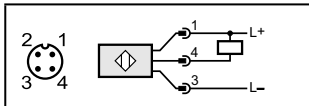

Receiver cable *

PNP

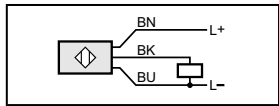

NPN

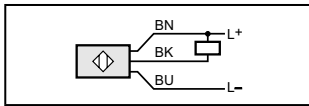



* Core colours: BN = brown, BU = blue, BK = black

6 Settings

6.1 Sensitivity setting

The sensor is to switch when the object is detected

1	<p>▶ Position the object.</p>  <p>receiver</p> <p>transmitter</p> <p>▶ Press [OUT on] for 2 s. > The sensitivity is set to the object. The yellow LED flashes.</p>
2	<p>▶ Remove the object.</p>  <p>receiver</p> <p>transmitter</p> <p>▶ Press [OUT off]. > The sensitivity is set without object. > The yellow LED goes out. The setting operation is completed.</p>

The sensor is not to switch when the object is detected

- ▶ Position the object (see figure 1) and press [OUT off].
- ▶ Remove the object (see figure 2) and press [OUT on].

You can carry out the setting first without object and then with object.

6.2 Setting of maximum sensitivity

- ▶ Interrupt the light beam.

The sensor is to switch when the object is detected.

- ▶ First press [OUT on], then [OUT off].

The sensor is to switch when the object is not detected

- ▶ First press [OUT off], then [OUT on].

6.3 Setting unsuccessful

- > The LED flashes quickly, 8 Hz.
- > The sensor returns to the normal operating mode with unchanged values.

Possible causes

- Insufficient difference in measurements
- Max. programming time of 15 min. exceeded

6.4 Electronic lock

The unit can be locked electronically to prevent unauthorised setting. On delivery the unit is not locked.

<ul style="list-style-type: none"> ▶ Press [OUT on] and [OUT off] simultaneously for 10 s. > Acknowledgement is indicated by a change of the LED status. ▶ To unlock repeat this step. 	 <p>receiver</p>
--	---

UK

7 Operation

- ▶ Check whether the unit operates correctly.
- > The green LED (transmitter) is lit when the sensor is ready for operation.
- > The output is switched when the object is present. The yellow LED (receiver) is lit.

8 Maintenance, repair, disposal

- ▶ Keep the lens of the sensor free from soiling.
- ▶ For cleaning do not use any solvents or cleaning agents which could damage the plastic parts.
- ▶ After use dispose of the unit in an environmentally friendly way in accordance with the applicable national regulations.

Faulty sensors must only be repaired by the manufacturer.

